

A Continuous-Discrete Mode of Optimal Control of AGC for Multi Area Hydrothermal System Using Genetic Algorithm

Mokenapalli.Vijay
Department of Electrical Engineering
NITK, Surathkal
Mangalore, India
mokenapalli.vijay@gmail.com

Debashisha Jena,
Department of Electrical Engineering
NITK, Surathkal
Mangalore, India
bapu4002@gmail.com

Abstract— This paper deals with Automatic generation control (AGC) of interconnected hydrothermal system in continuous-discrete mode using proportional-integral (PI) controller with different tuning approaches. Here the PI controller is initially tuned using local optimization technique such as Fminsearch (Existing MATLAB function) and optimal control strategies were taken as integral square error (ISE), integral time-absolute error (IATE) and integral time square error (ISTE). Then the same PI controller is tuned by using evolutionary algorithm i.e. genetic algorithm (GA). For the given system appropriate generation rate constraint (GRC) has been considered both for the thermal and hydro plants. System performances is examined considering 1% step load perturbation in both thermal and hydro area with 1 second sampling period. Finally the performance of both the local and global optimization algorithms is compared in terms of the time domain specifications both for frequency deviation in each area, and tie line power. **Keywords** component; Automatic generation control, PID controller, optimum criterion, Fminsearch and Genetic algorithm **Introduction (Heading 1)**

I. INTRODUCTION

POWER system operation considered so far was under conditions of steady load. However, both active and reactive power demands are never steady and they continuously change with rising and falling trend. So to meet the active and reactive power demand the steam input to turbo generators (or water input to the hydro generators) must be continuously regulated. Failing which the machine speed will vary with consequent change in frequency which may be highly undesirable (the maximum permissible change in frequency is $\pm 0.5\%$ HZ).

The excitation of generator must be continuously regulated to match the reactive power demand with reactive generation; Otherwise the voltages at various system buses may go beyond [1]. An interconnected power system consists of control areas which are connected to each other by tie lines. In a control area, all the generators speed up or slow down together to maintain the frequency and relative power angles to scheduled values in static as well as dynamic conditions. In

an interconnected power system, any sudden small load perturbation in any of the interconnected areas causes the deviation of frequencies of all the areas and also of the tie line powers. In modern large interconnected system, manual regulation is not feasible and therefore automatic generation and voltage regulation equipment is installed on each generator. From a practical point of view, the problems of frequency control of interconnected areas, or power pools, are more important than those of isolated areas. Practically, all power systems today are tied together with neighboring areas, and the problem of load frequency control becomes a joint undertaking. Closely associated is the problem of controlling the power flows on the inter ties. Many advantages can be derived from pool operation, and they can all be summarized in two words, mutual assistance.

A perturbation like adding a block of load in a single area power system operating at nominal value of frequency creates the power mismatch in generation and demand. However, if the mismatch is large enough, the governors come into action and the output of generators is increased. Since despite the action of governors the frequency is still different than nominal value, it is further needed to bring the frequency back to nominal value by another precise control strategy [2].

A governor designed with larger value of Speed Regulation parameter 'R' will be simpler and cheaper. A Sensitivity analysis for an AGC system with a higher value 'R' reveals that the optimum integral gain setting obtained for normal system parameters is quite robust for a $\pm 25\%$ change in system parameters. The AGC problem of a two area reheat thermal system provided with Integral controllers considering the power system operating in the continuous mode and the controller operating in the discrete mode is discussed in [3]. In the uncontrolled and unconstrained mode of AGC dynamic performance of the system deteriorates for higher values of 'R'. However, in the presence of a realistic stringent GRC, the dynamic Responses are nearly the same for wide range of values of 'R'. In the controlled mode with GRC there is no need to go for a low value of R because a relative large value of 'R' with corresponding optimum controller gain settings can be proffered as providing better dynamics performance of AGC [3].

The conclusion drawn by Nanda and Kaul [4] for selection of the governor speed regulation parameter R based on continuous-time analysis is found to be valid for a more realistic system modeling where the controller is in the discrete form and the system in the continuous form. The natural choice for AGC falls on either thermal or hydro units. The characteristics of hydro turbine differ from steam turbine in many respects [5-7]. The hydro governor is provided with a relatively large temporary droop and long washout time. The typical value of permissible rate of generation for hydro plant is relatively much higher (a typical value of generation rate constraints (GRC) being 270%/min for raising generation and 360%/min for lowering generation), as compared to that for reheat type thermal units having GRC of the order of 3%/min [8]. In [9] the authors have addressed about judiciously choosing of optimum sampling period T by considering a relatively larger value of the sampling period than the providing the maximum margin of stability. In the discrete mode of AGC for all practical purposes the unconstrained optimum integral gain (neglecting GRC) is acceptable even for the constrained mode (considering GRC) unlike in the continuous mode. Thus for obtaining more or less optimum integral gain the GRC can be neglected from the mathematical model. The performance of either the optimum P-I or the optimum integral controllers even in the presence of GRC is not much different from each other for all practical purposes [10]. To the best of the author's knowledge, no work has been reported in the literature for AGC of a hydrothermal system using genetic algorithm as an optimization tool for different optimal strategies such as ISE, ISTE and IATE in the continuous-discrete mode. In view of the above discussion, the following are the main objectives of the present work.

- To compare the performances of an optimum Integral (I) and Proportional-integral (PI) controllers for AGC of a hydrothermal system in continuous-discrete mode considering GRC, and reheat turbine in the thermal area.
- To compare the performances of an optimum Integral and Proportional-integral (PI) controllers for AGC of a hydrothermal system using a global search algorithm such as GA and local optimization algorithm which is basically a direct search algorithm.
- The simulation for different optimal criterion such as ISE, IATE and ISTE has been done and a suitable conclusion has been drawn in terms of the time domain specification.

II. PID CONTROLLER

Output of PID controller is given by

$$u(t) = K_p e(t) + K_i \int e(t) dt + K_d \frac{de(t)}{dt} \quad (1)$$

Where, error $e(t)$ = set point-plant output. $u(t)$ = Input to the plant or output of the controller, K_p = proportional gain, K_i = integral gain and K_d = derivative gain

III. OPTIMAL CONTROL SYSTEM

A control system is optimum when the selected performance index is minimised. The optimum value of the system

parameters depends directly on the definition of optimality. Mostly these are involving with Zero Steady state step error systems; The essential function of a feedback control system is to reduce the error, $e(t)$, between any variable and its demanded value to zero as quickly as possible. Therefore, any criterion used to measure the quality of system response must take into account the variation of error over the whole range of time. Equation (2) gives the general form of the optimum criterion.

$$J = \int_0^{\infty} [t^n e(\theta, t)]^2 dt \quad (2)$$

Where, $e(\theta, t)$ is the error signal which enters the PID controller, with θ the PID controller. In particular, three values of n are discussed, i.e., for $n = 0, 1, 2$. These three cases correspond, respectively, to three different optimum criteria: the integral squared error (ISE) criterion, integral squared time weighted error (ISTE) criterion, and the integral squared time-squared weighted error (IST2E) criterion [11]. Generally four basic criteria are in common use i.e.

1. Integral Square Error (ISE)
2. Integral of the Absolute magnitude of Error (IAE)
3. Integral Time – Absolute Error (IATE)
4. Integral Time- Square Error (ITSE)

This work has taken the first three criterion mentioned above and compares their performances to conclude which one is better for the system taken into consideration.

IV. FMINSEARCH

Fminsearch finds the minimum of a scalar function of several variables, starting at an initial estimate. This is generally referred to as unconstrained nonlinear optimization. $x = \text{fminsearch}(\text{fun}, x_0)$ starts at the point x_0 and returns a value x that is a local minimize of the function described in fun. x_0 can be a scalar, vector, or matrix. fun is a function handle. $x = \text{fminsearch}(\text{fun}, x_0, \text{options})$ minimizes with the optimization parameters specified in the structure options. You can define these parameters using the optimist function. Fminsearch uses these options structure fields. $x = \text{fminsearch}(@\text{myfun}, x_0)$ Where myfun is an M-file function such as function $f = \text{myfun}(x)$.

Fminsearch uses the simplex search method. This is a direct search method that does not use numerical or analytic gradients. If n is the length of x , a simplex in n -dimensional space is characterized by the $n+1$ distinct vectors that are its vertices. In two-space, a simplex is a triangle; in three-space, it is a pyramid. At each step of the search, a new point in or near the current simplex is generated. The function value at the new the simplex and, usually, one of the vertices is replaced by the new point, giving a new simplex. This step is repeated until the diameter of the simplex is less than the specified tolerance [12].

V. GENETIC ALGORITHM

Genetic Algorithm is computational models of biological evaluation. GA solves optimization problem by exploitation of random search. When searching a large space GA may be offer significant benefits over the traditional Optimization Techniques such as i). They work on encoding of control variables, rather than variables themselves. ii). They search from one population to another, rather than from individual to individual. iii). They use objective functions, not derivatives,

hence they are derivative free Optimization Technique and they don't delay on the detailed model of the system to optimized[13]. In this problem GA is used to optimize the gains of conventional PI controller with ISE, IATE and ISTE as fitness functions.

VI. SYSTEM TAKEN INTO CONSIDERATION

The AGC system instigated consists of two generating area of equal size, area 1 comprising reheat thermal system and area 2 comprising a hydro system. GRC of the order of 3%/min for thermal area and 270% per minute for rising and 360% per minute for lowering generation in hydro area has been considered. Fig. 2 shows the AGC model with single stage reheat turbine in thermal area and electrical governor in hydro area. A bias setting of $B_i = \beta_i$ is considered in both hydro and thermal areas. MATLAB version 7.9 has been used, to obtain dynamic responses for $\Delta f_1, \Delta f_2$ and ΔP_{tie} for 1% step load perturbation in both areas. The system has taken from [5], and [14], given in Appendix. The optimum values of derivative, proportional and integral gains for the electric governor have taken from the work of Nanda [4] and given in the Appendix. For the system analysis, 1% step load perturbation has been considered in both areas. Controller in both the areas have been optimized using integral square error (ISE) criterion, integral time-square error (ISTE) criterion and integral time absolute error (IATE) criterion.

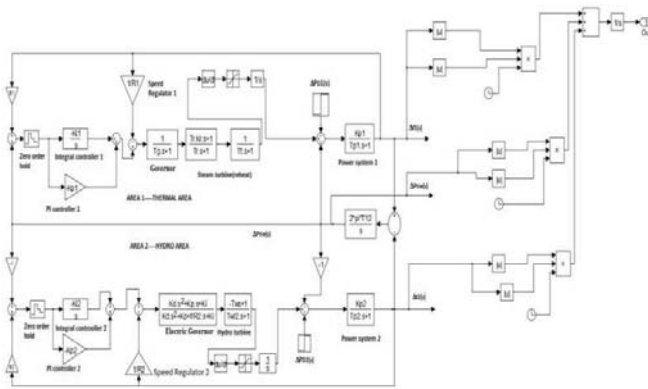

Fig.1. Transfer function model of an interconnected two area hydrothermal system with ISTE Optimum Technique

Table: I. Objective function values (J), for various Optimum Methods for an Inter connected area consisting of non-reheat turbine model in thermal area.

Optimum Techniques	Value of objective function(J)			
	Fminsearch		GA	
	Integral controller	PI controller	Integral controller	PI controller
IATE	12.855	3.9878	12.6965	5.08735
ISE	0.02476	0.01701	0.0245	0.016263
ITSE	0.06263	1.2096	0.06237	1.22319

Table: II. PI Tuning parameters from Fminsearch Method for an interconnected area consisting of non-reheat turbine model in thermal area

S.No	Controlling parameters	From fminsearch					
		IATE		ISE		ISTE	
		Integral controller	PI controller	Integral controller	PI controller	Integral controller	PI controller
1	Ki1	0.108	0.105	0.102	0.113	0.129	-1.76
2	Kp1	0	0.116	0	0.109	0	14.342
3	Ki2	0.105	0.125	0.103	0.111	0.112	-16.017
4	Kp2	0	0.028	0	0.064	0	56.461

Table: III. PI Tuning parameters from GA Method for an interconnected area consisting of non-reheat turbine model in thermal area

S.No	Controlling parameters	From Genetic Algorithm					
		IATE		ISE		ISTE	
		Integral controller	PI controller	Integral controller	PI controller	Integral controller	PI controller
1	Ki1	0.149	0.368	0.11	0.187	0.119	0.024
2	Kp1	0	0.275	0	0.806	0	0.938
3	Ki2	0.089	0.239	0.123	0.146	0.123	0.924
4	Kp2	0	0.043	0	0.04	0	8.463

VII. RESULT AND DISCUSSIONS

Initially the Simulation has been done by taking the system under consideration as shown in Fig.1, with reheat and non-reheat turbine model of the thermal area. For both type of control areas the Optimal Criterion is taken as IATE, ISE and ISTE. The Simulation results for the frequency deviation in both areas and tie line power for all the 3-cases of Optimal Criterion mentioned above with Conventional controller and GA controller is properly analysed. The interconnected area Consisting non-reheat turbine model in thermal area for IATE, ISE and ISTE has shown in the Fig.2, Fig.3 and Fig.4 respectively. For the conventional controller (i.e. I and PI Fminsearch) is taken as Optimization algorithm for all the cases of Optimal Criterion. This result is compared by taking the Optimization algorithm as Genetic Algorithm. Table. I shows the value of objective function for all an interconnected area consisting non-reheat turbine model in thermal area. From the Table it is clear that the objective function value for is ISE much less than the other two Optimal Criterion (i.e. IATE and ISTE). Table.II shows the value of I and PI parameters (i.e. K_p and K_i values) for conventional method. Table.III gives the value of the I and PI parameters from GA. Similarly Table .IV shows the value of objective function for point is compared with the function values at the vertices of an interconnected area consisting of Reheat turbine model in thermal area. Fig.5, Fig.6 and Fig.7 represents dynamic responses for various optimum criterions. Table.V and Table.VI shows the values of the I and PI parameters from Conventional and GA methods respectively.

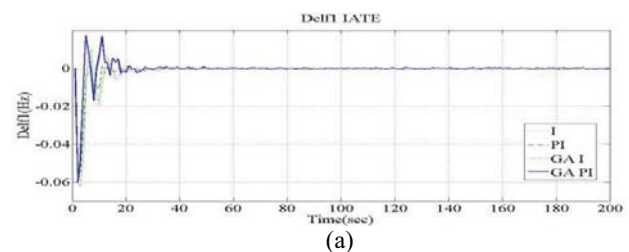

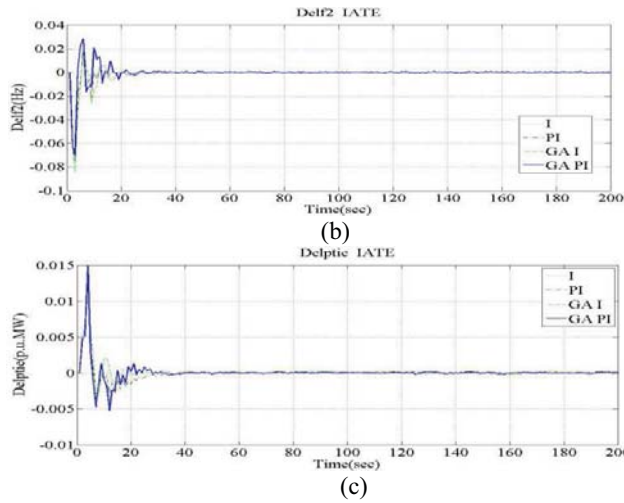

Fig.2. Comparison of integral and PI controller responses with 1% step load perturbation in hydrothermal area with IATE. (a) $\Delta f_1=f(t)$, (b) $\Delta f_2=f(t)$ and (c) $\Delta p_{tie}=f(t)$.

Figure 2 (a) gives the comparison of frequency deviation in Thermal area. Figure 2(b) gives the comparison of frequency deviation in hydro area. Figure 2(c) shows the deviation in tie line power. All those cases are taken for IATE criterion and the comparison is done between Fminsearch and GA.

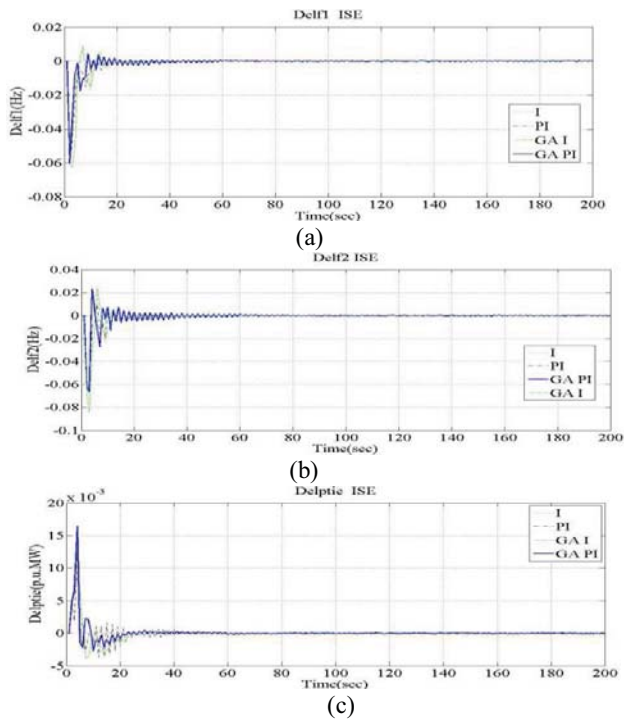

Fig.3. Comparison of integral and PI controller responses with 1% step load perturbation in hydrothermal area with ISE. (a) $\Delta f_1=f(t)$, (b) $\Delta f_2=f(t)$ and (c) $\Delta p_{tie}=f(t)$.

Figure 3 (a) gives the comparison of frequency deviation in thermal area. Figure 3(b) gives the comparison of frequency deviation in hydro area. Figure 3(c) shows the deviation in tie line power. All those cases are taken for ISE criterion and the comparison is done between Fminsearch and GA.

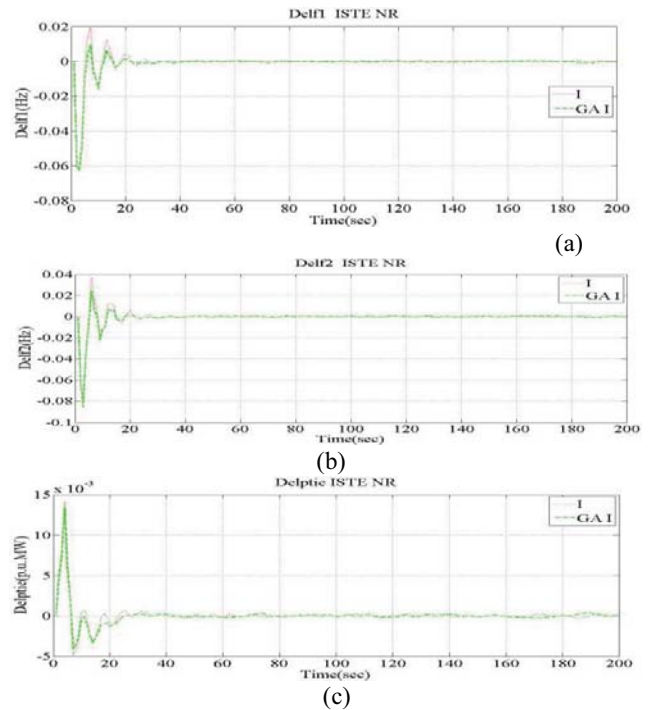

Fig.4. Comparison of integral and PI controller responses with 1% step load perturbation in hydrothermal area with ISTE. (a) $\Delta f_1=f(t)$, (b) $\Delta f_2=f(t)$ and (c) $\Delta p_{tie}=f(t)$.

Figure 4 (a) gives the comparison of frequency deviation in Thermal area. Figure 4(b) gives the comparison of frequency deviation in hydro area. Figure 4(c) shows the deviation in tie line power. All those cases are taken for ISTE criterion and the comparison is done between Fminsearch and GA.

Table: IV. Objective function values (J), for various Optimum Methods for an Inter connected area consisting of reheat turbine model in thermal area.

Optimum Techniques	Value of objective function(J)			
	Fminsearch		GA	
	Integral controller	PI controller	Integral controller	PI controller
IATE	45.76609	11.07763	36.20843	11.11807
ISE	0.066456	0.028434	0.061434	0.023167
ITSE	0.352133	0.077985	0.310816	0.053674

Table: V. PI Tuning parameters from Fminsearch Method for an Interconnected area consisting of reheat turbine model in thermal area.

S.No	Controlling parameters	From fminsearch					
		IATE		ISE		ISTE	
		Integral controller	PI controller	Integral controller	PI controller	Integral controller	PI controller
1	Ki1	0.103	0.104	0.112	0.103	0.0526	0.0954
2	Kp1	0	0.109	0	0.104	0	0.1150
3	Ki2	0.1	0.12	0.034	0.114	0.0948	0.1135
4	Kp2	0	0.05	0	0.083	0	0.0743

Table: VI. PI Tuning parameters from GA Method for an interconnected area consisting of reheat turbine model in thermal area.

From Genetic Algorithm							
S.No	Controlling parameters	IATE		ISE		ISTE	
		Integral controller	PI controller	Integral controller	PI controller	Integral controller	PI controller
1	KI1	0.0543	0.1534	0.051	0.12	0.0391	0.1216
2	Kp1	0	0.1959	0	0.98	0	0.9699
3	KI2	0.0845	0.2048	0.046	0.136	0.0676	0.1790
4	Kp2	0	0.0730	0	0.067	0	0.0568

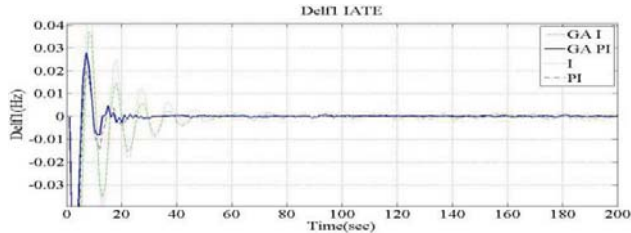

(a)

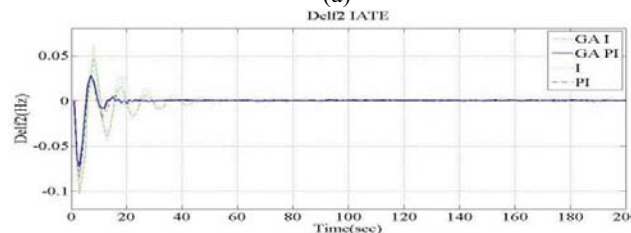

(b)

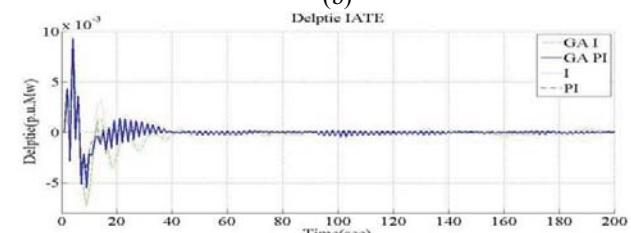

(c)

Fig.5.Comparison of integral and PI controller responses with 1% step load perturbation in hydrothermal area with IATE. (a) $\Delta f_1=f(t)$, (b) $\Delta f_2=f(t)$ and (c) $\Delta p_{tie}=f(t)$.

Figure 5 (a) gives the comparison of frequency deviation in Thermal area. Figure 5(b) gives the comparison of frequency deviation in hydro area. Figure 5(c) shows the deviation in tie line power. All those cases are taken for IATE criterion and the comparison is done between Fminsearch and GA.

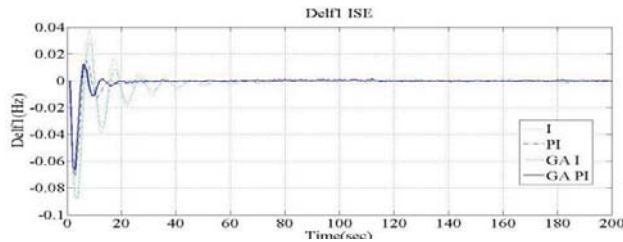

(a)

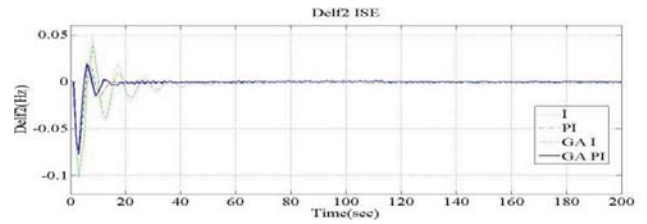

(b)

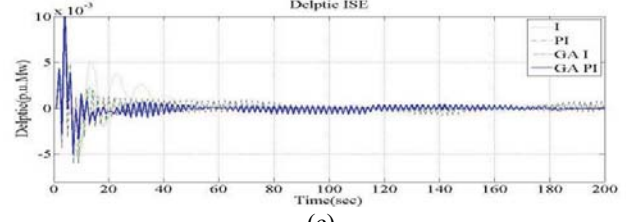

(c)

Fig.6.Comparison of Integral and PI controller responses with 1% step load perturbation in hydrothermal area with ISE. (a) $\Delta f_1=f(t)$, (b) $\Delta f_2=f(t)$ and (c) $\Delta p_{tie}=f(t)$.

Figure 6 (a) gives the comparison of frequency deviation in Thermal area. Figure 6(b) gives the comparison of frequency deviation in hydro area. Figure 6(c) shows the deviation in tie line power. All those cases are taken for ISE criterion and the comparison is done between Fminsearch and GA.

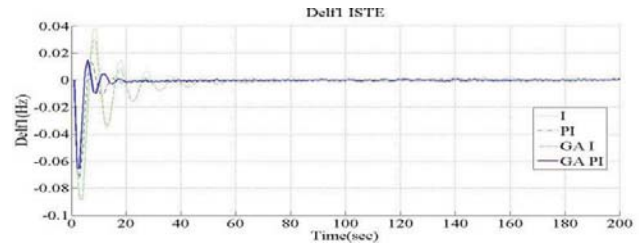

(a)

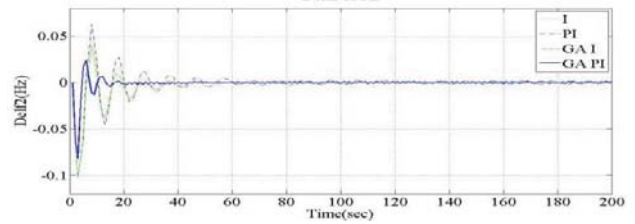

(b)

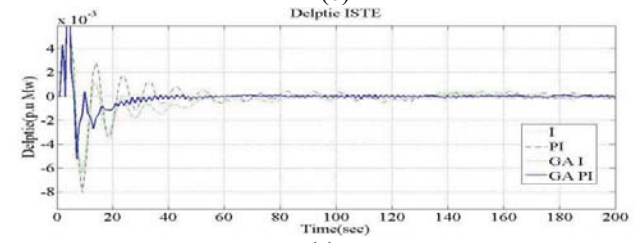

(c)

Fig.7.Comparison of Integral and PI controller responses with 1% step load perturbation in hydrothermal area with ISTE. (a) $\Delta f_1=f(t)$, (b) $\Delta f_2=f(t)$ and (c) $\Delta p_{tie}=f(t)$.

Figure 7 (a) gives the comparison of frequency deviation in Thermal area. Figure 7(b) gives the comparison of frequency deviation in hydro area. Figure 7(c) shows the deviation in tie line power. All those cases are taken for ISTE criterion and the comparison is done between Fminsearch and GA.

VIII. CONCLUSIONS

From the above results it concluded that for the AGC system in continuous-discrete mode taken under consideration, ISE Optimal criterion gives better time domain performance in Comparison with IATE and ISTE for conventional controller and GA controller. It is found that PI tuning with global search algorithm (i.e. Genetic Algorithm) gives best responses rather than PI Tuning with a direct search algorithm (i.e. Fminsearch). For reheat turbine model the performance of ISE is closer to ISTE but for non-reheat case ISE gives a superior Performance than ISTE. For all the cases it is clear that IATE is not suitable for the system taken under consideration. Simulations for different sampling are under the future scope of the work.

PARAMETERS USED IN SIMULATION STUDIES

Fminsearch	
Max iterations	200*No of variables
Max evaluations	200*No of variables
X tolerance	$1 * e^{-4}$
Function tolerance	$1 * e^{-4}$
Genetic Algorithm	
Initial Population Size	20
PopChromosome Length	24bit
Number of generations	100
Fitness Function	IATE, ISE, ISTE
Elitism	2
Crossover Probability	0.8
Mutation Probability	0.2
No. of Generations	100

Nominal parameters of hydrothermal system	
f =60 Hz	D1 =D2=8.33*10 p.u. Mw/ Hz
Tg =0.08 sec	R1=R2 =2.4 Hz/p.u.Mw
Tr =10.0 sec	Tt =0.3 sec
H1 = H2 = 5 sec	Kp=1.0
P1 = P2 =2000 MW	Kd=4.0
Ptie, max =200MW	Ki=5.0
Kr = 0.5	Tw=1.0 sec
Kp1=Kp2=120Hz/p.u.Mw	Tp1=Tp2=20 sec
a12 = -1	T12 = 0.086p.u.Mw/rad

REFERENCES

- [1] D. P. Kothari, I J Nagrath. *Modern Power System Analysis 3rd ed.* New Delhi: Tata McGraw-Hill, 2003.
- [2] O.I.Elgerd. *Electric Energy Systems Theory: An Introduction.2nd ed.*NewDelhi: Tata McGraw-Hill; 1983.
- [3] L Hari, ML Kothari, and J.Nanda. "Optimum selection speed regulation parameters for automatic generation control in discrete mode considering generation rate constraints." *IEE Proc C.*, vol.138.no.5, pp.401-6, 1991.
- [4] J. Nanda, and B. L. Kaul, "Automatic generation control of an interconnected power system", *IEE, Proc.*, vol.125, no.5, pp. 385-390, 1978.
- [5] C.Concordia, and L.K.Kirchamayer. "Tie-line power and frequency control of electric power system: part II." *AISE Trans, III-A.*, vol.73, pp.133-146, Apr.1954.
- [6] L.K Kirchamayer, *Economic Control of Interconnected Systems.*Newyork: Wiley, 1959.
- [7] D.G. Ramey, and J.W. Skooglund, "Detailed hydro governor representation for system stability studies", *IEEE Trans. Power App.Syst.*, vol.89, no.1, pp.106-112, Jan1970.
- [8] J. Nanda, Ashish Mangla, and Sanjay suri. "Some New Findings on automatic generation control of Interconnected Hydrothermal system with conventional controllers." *IEEE Trans*, vol.21, 2006.
- [9] ML Kothari, P.S Satsangi, and J.Nanda, "Sampled-data Automatic generation control of an Interconnected Reheat thermal system considering generation constraints", *IEEE Trans*, vol.PAS-100, 1981.
- [10] E.V.Bohn, and S.M.Minnissy., " Optimum Load-Frequency Sampled-Data control with Randomly Varying System and Disturbances.,", *IEEE Trans*, vol.PAS-91, pp.2095-2103, 1972
- [11] I J Nagrath , M.Gopal. *Control Systems Engineering: 2nd ed.*New Delhi: Wiley, 1981.
- [12] J.C Lagarias, J.A Reeds, M.H.Wright, and P.E Wright. "Convergence Properties of the Nelder-Mead simplex method in low dimensions," *SIAM Journal of Optimization*, vol.9 November1, pp.112-147, 1988.
- [13] K.S.S. Ramakrishna, and T.S.Bhatti, "Load Frequency control of an Interconnected hydrothermal power systems," *ICEE*, 2006.
- [14] O.I Elgerd and C.E Fosha. "Optimum megawatt-frequency control of multi area electric energy systems," *IEEE Trans.PowerApparent.syst.*, vol.PAS-89.no.4, pp.556-563, Apr.1970.